

TEMPLATE OF 45-RIM / F45-RIM DEVICE

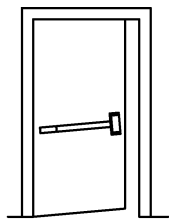

RHR

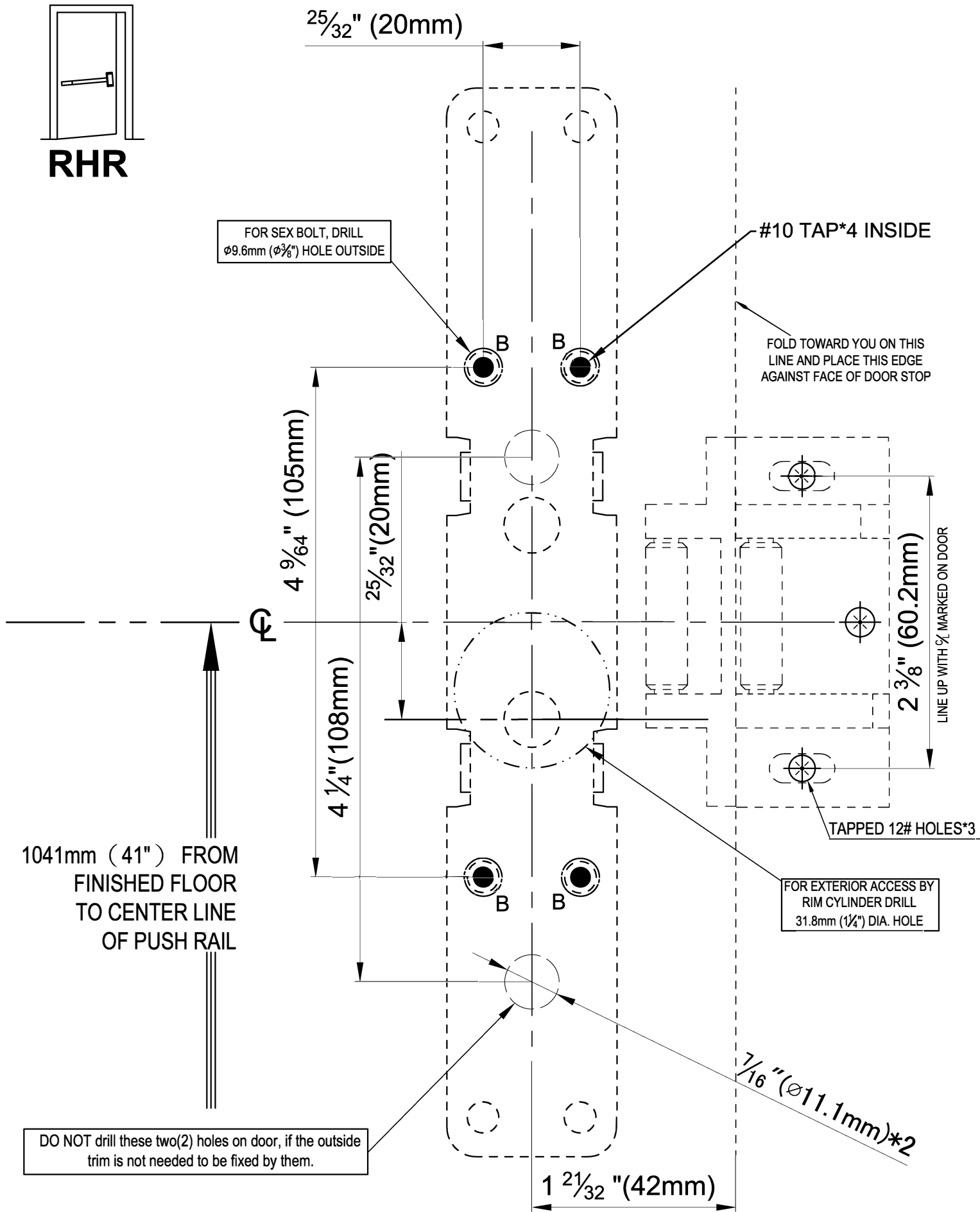

TEMPLATE OF 45-RIM / F45-RIM DEVICE

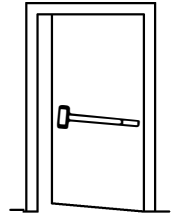

LHR

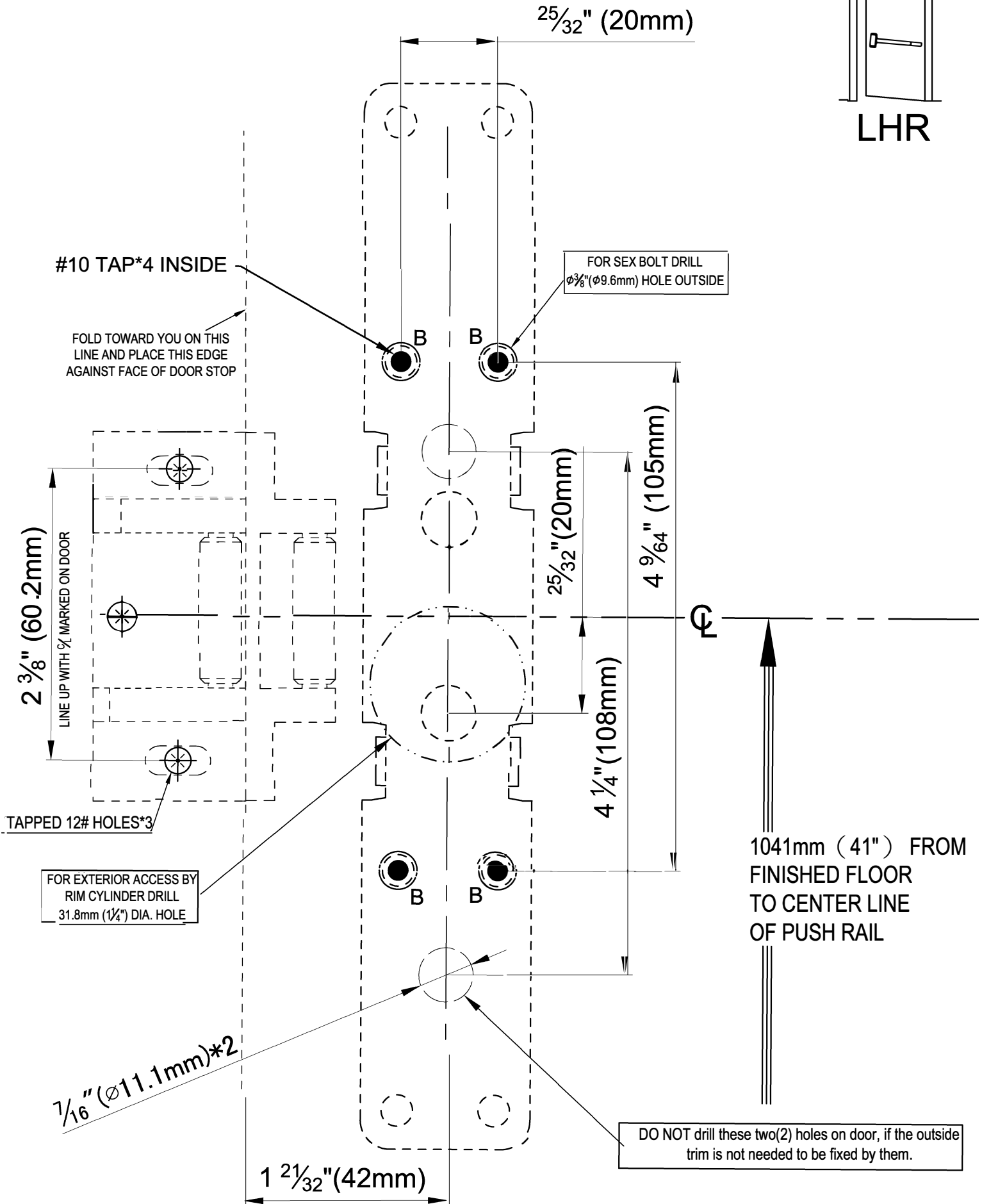

TEMPLATE OF 45-SVR / F45-SVR DEVICE

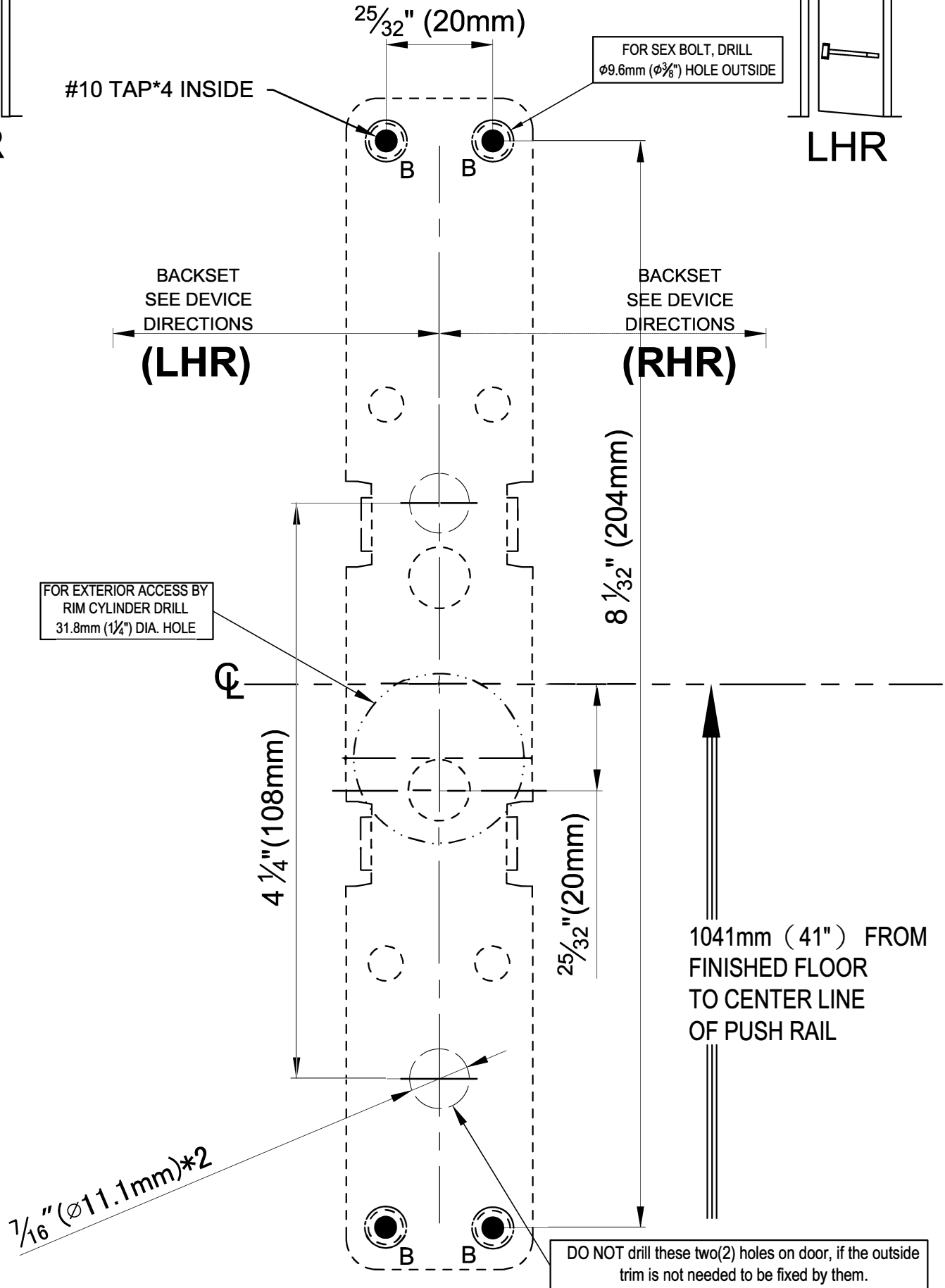
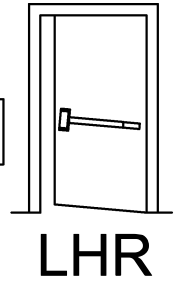
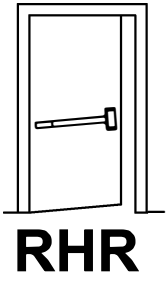

TEMPLATE of Bottom LATCH (1:1)

【Handicap Strike (Optional use)】

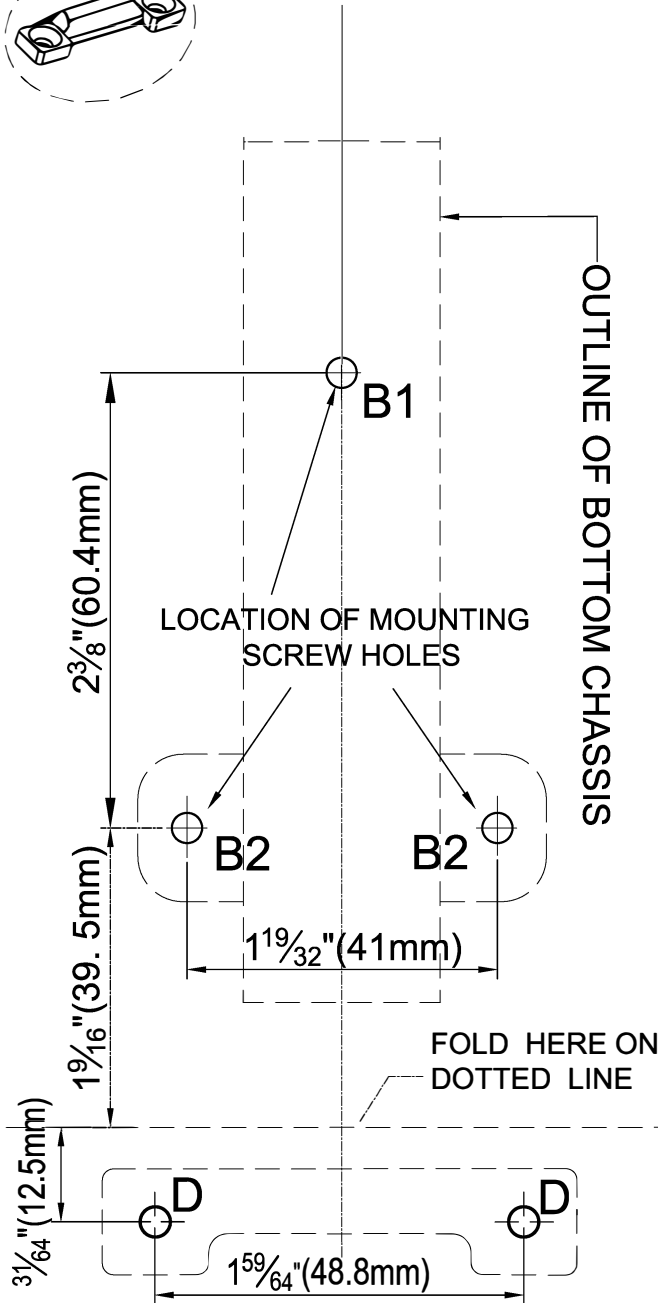
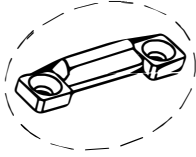

TEMPLATE of Bottom LATCH (1:1)

【Mortise in Strike (Optional use)】

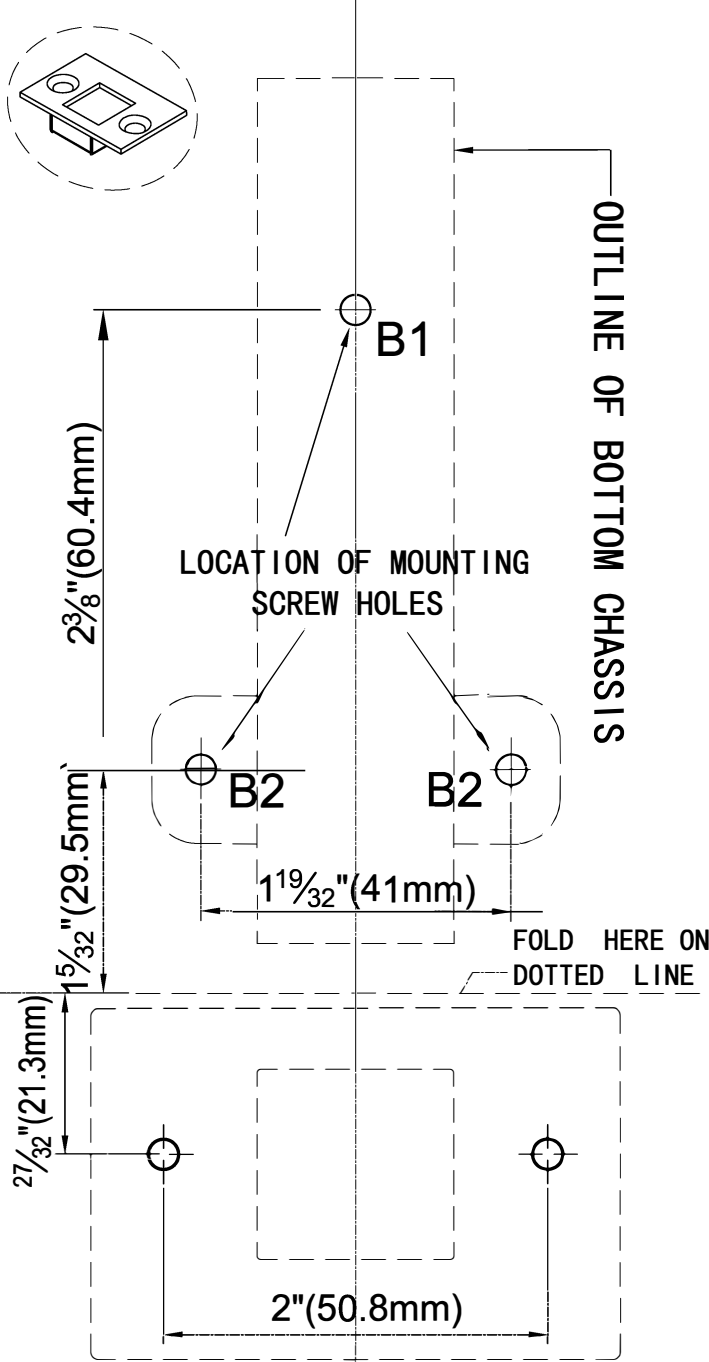
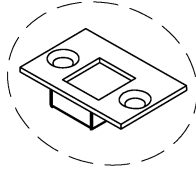

TEMPLATE of Top LATCH (1:1)

【Top Strike (regular use)】

